

Approvals & Certifications

- ASME B16.51
- IAPMO PS-117
- NSF/ANSI 61
- NSF/ANSI 372
- CSA TIL-MSE-13

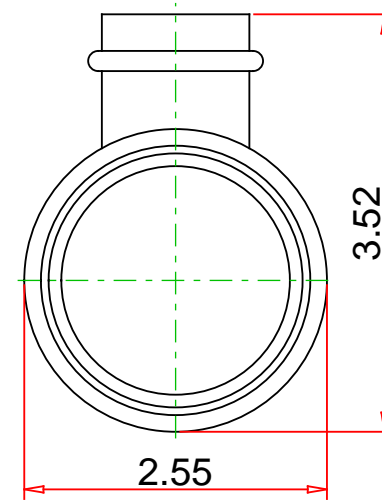
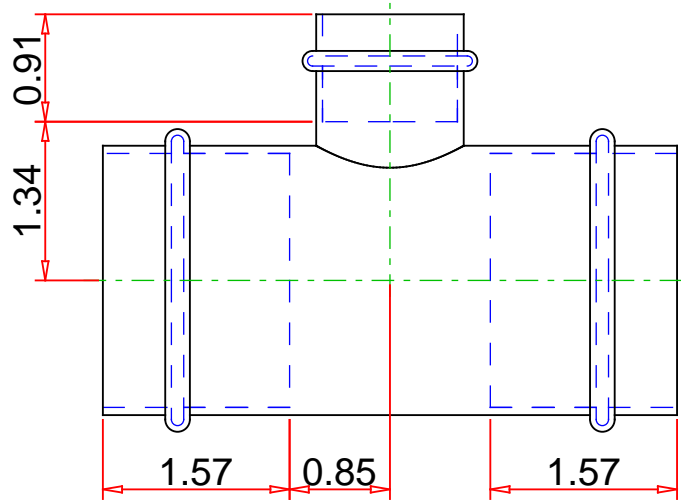
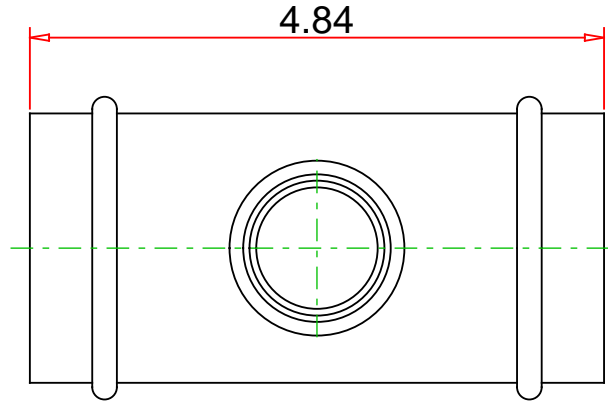

Note : - Drawing not to Scale

DISCLAIMER: DIMENSIONS ARE APPROXIMATE AND ARE SUBJECT TO CHANGE WITHOUT NOTICE.
 ALL ASME DIMS ARE MINIMUM. LAY LENGTH DIMS ARE ± 0.06
 ALL OTHER DIMS ARE NOMINAL. ALL DIMS ARE IN INCHES.

© 18-JUN-2019 Mueller Industries, Inc.

Part No. :

PF 40105

Description :

Copper Tee, P x P x P, 2" x 2" x 1"



Mueller Streamline Co.

Address : 8285 Tournament Dr., Suite 150
 Memphis, TN 38125

Ph : 901-753-3200

Email : contact@muellerindustries.com

Web : <http://www.muellerindustries.com/>